

Junction prior to cladding around window head

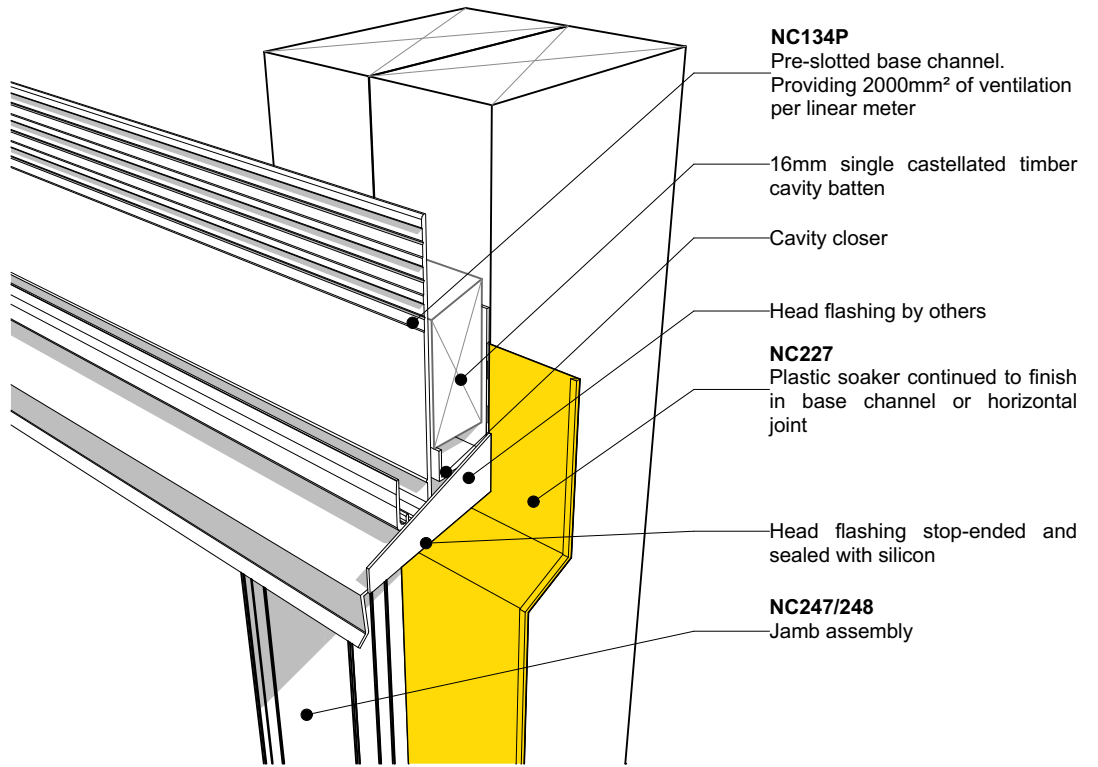

Junction after cladding around window head

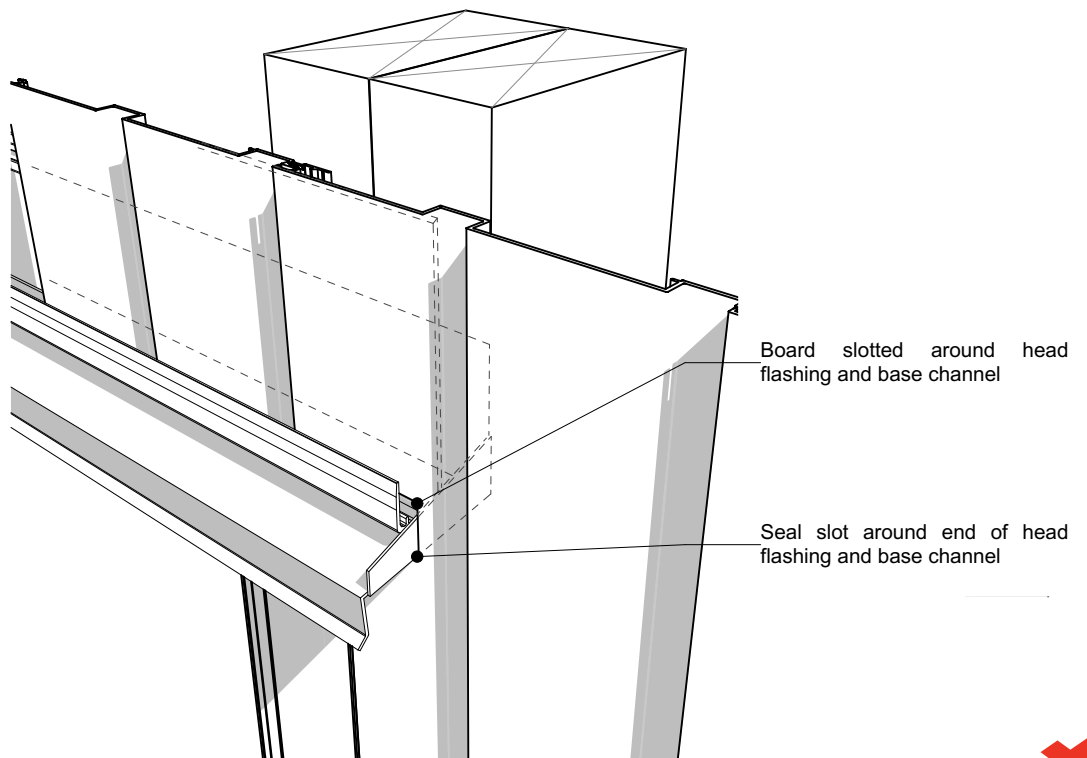

Nu-Wall cladding vertical direct fix
Typical head flashing end detail

© 2021 copyright in this document is the property of Nu-Wall Aluminium Cladding Limited. All rights reserved. Nu-Wall is a registered trademark of Aluminium Product Brands NZ Limited

NW-VDF-015.01

Drawn by: Nu-Wall Date: 9/05/2022

Checked by: RL, GT Scale: NTS